

The Keithley logo consists of the word "KEITHLEY" in white, uppercase, sans-serif font, centered within a solid red rectangular background.

KEITHLEY

Model 182 Sensitive Digital Voltmeter

Quick Reference Guide

A large, faint, light gray graphic in the background of the lower half of the page. It appears to be a stylized, abstract shape that could be interpreted as a hand or a leaf, with several rounded, irregular shapes extending from a central curved base.

A GREATER MEASURE OF CONFIDENCE

INTRODUCTION

This quick reference guide includes summary information on front panel operation and IEEE-488 operation for the Model 182 Sensitive Digital Voltmeter. For detailed Model 182 information, consult the Model 182 Instruction Manual.

TABLE OF CONTENTS

SAFETY PRECAUTIONS	3
CONTROL SUMMARY	8
TEST CONNECTIONS	14
DEVICE DEPENDENT COMMANDS	15
DATA FORMATS	23
SRQ MASK AND SERIAL POLL BYTE	25
ALTERNATE OUTPUT WORD FORMATS	26

SAFETY PRECAUTIONS

The following safety precautions should be observed before using this product and any associated instrumentation. Although some instruments and accessories would normally be used with non-hazardous voltages, there are situations where hazardous conditions may be present.

This product is intended for use by qualified personnel who recognize shock hazards and are familiar with the safety precautions required to avoid possible injury. Read the operating information carefully before using the product.

The types of product users are:

Responsible body is the individual or group responsible for the use and maintenance of equipment, for ensuring that the equipment is operated within its specifications and operating limits, and for ensuring that operators are adequately trained.

Operators use the product for its intended function. They must be trained in electrical safety procedures and proper use of the instrument. They must be protected from electric shock and contact with hazardous live circuits.

Maintenance personnel perform routine procedures on the product to keep it operating, for example, setting the line voltage or replacing consumable materials. Maintenance procedures are described in the manual. The procedures explicitly state if the operator may perform them. Otherwise, they should be performed only by service personnel.

Service personnel are trained to work on live circuits, and perform safe installations and repairs of products.

Only properly trained service personnel may perform installation and service procedures.

Keithley products are designed for use with electrical signals that are rated Installation Category I and Installation Category II, as described in the International Electrotechnical Commission (IEC) Standard IEC 60664. Most measurement, control, and data I/O signals are Installation Category I and must not be directly connected to mains voltage or to voltage sources with high transient over-voltages. Installation Category II connections require protection for high transient over-voltages often associated with local AC mains connections. The user should assume all measurement, control, and data I/O connections are for connection to Category I sources unless otherwise marked or described in the Manual.

Exercise extreme caution when a shock hazard is present. Lethal voltage may be present on cable connector jacks or test fixtures. The American National Standards Institute (ANSI) states that a shock hazard exists when voltage levels greater than 30V RMS, 42.4V peak, or 60VDC are present. A good safety practice is to expect that hazardous voltage is present in any unknown circuit before measuring.

Users of this product must be protected from electric shock at all times. The responsible body must ensure that users are prevented access and/or insulated from every connection point. In some cases, connections must be exposed to potential human contact. Product users in these circumstances must be trained to protect themselves from the risk of electric shock. If the circuit is capable of operating at or above 1000 volts, no conductive part of the circuit may be exposed.

Do not connect switching cards directly to unlimited power circuits. They are intended to be used with impedance limited sources. NEVER connect switching cards directly to AC mains. When connecting sources to switching cards, install protective devices to limit fault current and voltage to the card.

Before operating an instrument, make sure the line cord is connected to a properly grounded power receptacle. Inspect the connecting cables, test leads, and jumpers for possible wear, cracks, or breaks before each use.

When installing equipment where access to the main power cord is restricted, such as rack mounting, a separate main input power disconnect device must be provided, in close proximity to the equipment and within easy reach of the operator.

For maximum safety, do not touch the product, test cables, or any other instruments while power is applied to the circuit under test. ALWAYS remove power from the entire test system and discharge any capacitors before: connecting or disconnecting cables or jumpers, installing or removing switching cards, or making internal changes, such as installing or removing jumpers.

Do not touch any object that could provide a current path to the common side of the circuit under test or power line (earth) ground. Always make measurements with dry hands while standing on a dry, insulated surface capable of withstanding the voltage being measured.

The instrument and accessories must be used in accordance with its specifications and operating instructions or the safety of the equipment may be impaired.

Do not exceed the maximum signal levels of the instruments and accessories, as defined in the specifications and operating information, and as shown on the instrument or test fixture panels, or switching card.

When fuses are used in a product, replace with same type and rating for continued protection against fire hazard.

Chassis connections must only be used as shield connections for measuring circuits, NOT as safety earth ground connections.

If you are using a test fixture, keep the lid closed while power is applied to the device under test. Safe operation requires the use of a lid interlock.

If a screw is present, connect it to safety earth ground using the wire recommended in the user documentation.

The symbol on an instrument indicates that the user should refer to the operating instructions located in the manual.

The symbol on an instrument shows that it can source or measure 1000 volts or more, including the combined effect of normal and common mode voltages. Use standard safety precautions to avoid personal contact with these voltages.

The **WARNING** heading in a manual explains dangers that might result in personal injury or death. Always read the associated information very carefully before performing the indicated procedure.

The **CAUTION** heading in a manual explains hazards that could damage the instrument. Such damage may invalidate the warranty.

Instrumentation and accessories shall not be connected to humans.

Before performing any maintenance, disconnect the line cord and all test cables.

To maintain protection from electric shock and fire, replacement components in mains circuits, including the power transformer, test leads, and input jacks, must be purchased from Keithley Instruments. Standard fuses, with applicable national safety approvals, may be used if the rating and type are the same. Other components that are not safety related may be purchased from other suppliers as long as they are equivalent to the original component. (Note that selected parts should be purchased only through Keithley Instruments to maintain accuracy and functionality of the product.) If you are unsure about the applicability of a replacement component, call a Keithley Instruments office for information.

To clean an instrument, use a damp cloth or mild, water based cleaner. Clean the exterior of the instrument only. Do not apply cleaner directly to the instrument or allow liquids to enter or spill on the instrument. Products that consist of a circuit board with no case or chassis (e.g., data acquisition board for installation into a computer) should never require cleaning if handled according to instructions. If the board becomes contaminated and operation is affected, the board should be returned to the factory for proper cleaning/servicing.

CONTROL SUMMARY

RANGE

Use UP and DOWN to manually select desired measurement range; 3mV, 30mV, 300mV, 3V, or 30V. Present range is displayed on status line.

Press AUTO to turn auto-range on or off. Unit upranges at overflow point ($\pm 3,029,999$ counts) and downranges at 9.33% of full range when AUTO is enabled.

Use FILTER to enable or disable both digital and analog filters simultaneously (actual filter configuration or response depends on MENU FILTER selections).

REL

Press REL READING to store current reading as baseline. Subsequent readings will be the difference between the applied signal and the stored baseline.

Press REL OUTPUT to store current analog output value as analog output baseline. Analog output value will be the difference between the normal, non-relative output value and the stored analog output baseline.

TRIG

Press SETUP to program TRIGGER MODE, TRIGGER SOURCE, TRIGGER DELAY, AND TRIGGER INTERVAL.

Use ▲ or ▼ to scroll through selections, ENTER to select, or ESC to cancel selection.

TRIGGER MODE: select multiple (continuous with one trigger) or one-shot (one reading per trigger).

TRIGGER SOURCE: select external, manual, disabled, or IEEE-488 X, GET or talk triggers.

TRIGGER DELAY: program desired trigger delay (time between trigger and reading in one-shot trigger mode): 0sec-999.999sec.

TRIGGER INTERVAL: program desired trigger interval (time between individual readings in multiple trigger mode): 0.01 sec-999.999sec.

BUFFER

Use STORE to start/stop buffer data storage. Store size of 1-1024 selects linear buffer (storage stops when size limitation is reached); store size of 0 selects circular buffer (buffer wraps around and overwrites old data after 1024 readings are stored). Unit stores readings at programmed trigger interval in multiple trigger mode or one reading per trigger in one-shot trigger mode.

Press RECALL to access stored buffer readings and buffer statistics. Readings include buffer location and time stamp. Statistics include number of samples, buffer average, maximum, minimum, and standard deviation.

SELECTION

Use ▲ or ▼ to scroll through MENU, SETUP, and RECALL selections. Press ENTER to choose displayed selection and move down one menu level (where applicable). Press ESC to cancel displayed selection and move up one menu level (where applicable).

Use MENU to access operating modes summarized below.

MENU Message	Description
FILTER	Set digital filter response, analog filter on/off
INTEGRATION TIME	Set A/D integration period (3msec, line cycle, or 100msec)
DISPLAY RESOLUTION	Set display resolution to 3 1/2, 4 1/2, 5 1/2, or 6 1/2 digits
READING REL OUTPUT	Program reading relative value
SETUP	Set analog output gain and relative value
SET IEEE ADDRESS	Save user setup, recall user or factory default setup
CALIBRATE	Select IEEE-488 primary address (0-30)
	Display test, calibrate Model 182, configure analog output for normal or source

Press LOCAL to cancel remote (REM on) when the instrument is used over the IEEE-488 bus. LOCAL will be locked out when the bus LLO command is in effect.

FACTORY DEFAULT CONDITIONS

Description	Default State
Range	30V, auto-range off
Reading relative	Off, value =0V
Analog Filter	Off
Digital Filter	On, medium response
Buffer	Off, size = 0000 (wrap around)
Analog Output	Relative off, value: 0V, gain: 1.0, normal output, source value = 0V
Primary Address	7
Integration Period	Line cycle (16.67msec @ 60Hz, 20msec @ 50Hz)
Display Resolution	6 1/2 digits
Trigger Mode	Multiple
Trigger Source	External (MANUAL key also operative)
Trigger Interval	0.25sec
Trigger Delay	0sec
Calibration Lock	On (calibration locked)

NOTE: All listed operating states except buffer status, primary address, and calibration lock status can be saved as user configuration using MENU save user setup selection. Primary address can be saved using MENU SET IEEE ADDRESS selection.

ERROR MESSAGES

U1 Bit Number*	Display Message	Description	Type
0**	INVALID COMMAND	Invalid Device-Dependent Command	Momentary
1**	INVALID OPTION	Invalid Device-Dependent Command Option	Momentary
2**	INVALID FORMAT	Invalid Device-Dependent Command Format	Momentary
3**	NOT IN REMOTE	Unit not in remote when programmed	Momentary
4	TRIGGER OVERRUN	Unit triggered while processing reading (one-shot only)	Momentary
5	OVERFLOW	Input signal too large for range	Momentary
6	NVRAM ERROR	NVRAM error found during self-test	Latching
7	RAM ERROR	RAM error found during self-test	Latching
8	UNCALIBRATED Press a key to continue	Unit not calibrated	Latching

U1 Bit Number**	Display Message	Description	Type
9	CAL RUNNING	Invalid command or operation when calibration unlocked	Momentary
10	CAL LOCKED	Calibration attempted with calibration locked	Momentary
11	CAL ERROR Press a key to continue	Improper calibration value for applied signal	Latching
12		Reserved	
13		Reserved	
14	FRONT PANEL FAILURE	Front panel microcontroller communications failure	Latching
15	A/D COMM FAILURE	A/D microcontroller communications failure	Latching
16	TRIGGER NOT READY	Unit not ready for trigger	Momentary

* Number corresponds to bit position in U1 error word.

** IEEE-488 bus-only errors. INVALID FORMAT and INVALID OPTION commands display error type on lower line.

TEST CONNECTIONS

Note: Use only clean copper-to-copper connections to minimize thermals

Low thermal cable
(Model 1506 or Equivalent)

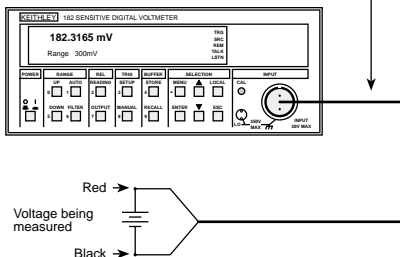

Caution
Maximum Input: 35V continuous
120V for 10 seconds

WARNING: Maximum common-mode
voltage: 350V peak

Figure 1. Typical Test Connections

DEVICE DEPENDENT COMMANDS

NOTE: Corresponding lower-case command letters may be used in place of upper-case command letters.

Display ASCII String	
A0	Restore display to normal
A1, string	Display string
A2, string	Display string and store in EEROM
A3	Display string stored in EEROM

NOTE: String must be surrounded by single quotes.

Display Resolution	
B0	5 1/2 digit resolution
B1	6 1/2 digit resolution
B2	3 1/2 digit resolution
B3	4 1/2 digit resolution

Measure and Analog Output Source Calibration

C0, value	Calibrate measure positive full scale
C1, value	Calibrate measure negative full scale
C2	Calibrate measure zero offset
C3, value	Calibrate divider full scale
C4	Calibrate divider zero
C5	Select positive full scale output
C6, value	Calibrate positive full scale output
C7	Select zero output value
C8, value	Calibrate zero output with value

Filter Damping

D0	Turn filter damping off (same as P2)
D1	Turn filter damping on (same as P3)

Reading Source

F0	Latest reading from A/D converter
F1	One reading from buffer
F2	All readings in buffer
F3	Maximum value in buffer
F4	Minimum value in buffer

Reading Format

G0	Reading only
G1	Reading with prefix
G2	Reading with buffer location
G3	Reading with buffer location and prefix
G4	Reading with time stamp
G5	Reading with time stamp and prefix
G6	Reading with time stamp and location
G7	Reading with time stamp, location, and prefix

Immediate Trigger and Self-test

H0	Initiate manual trigger
H1	Perform memory test

Buffer Configuration

I0	Disable buffer
I1, value	Buffer on, linear length=value
I2	Buffer on, circular length=1024

Analog Output Relative

J0	Disable analog output relative
J1	Enable analog output relative using next reading
J2, value	Enable analog output relative using value
J3	Enable analog output relative, use present value

EOI, Bus Hold-off on X

K0	Enable EOI, enable bus hold-off on X
K1	Disable EOI, enable bus hold-off on X
K2	Enable EOI, disable bus hold-off on X
K3	Disable EOI, disable bus hold-off on X

Save and Recall Setup

L0	Save current setup as power-on
L1	Recall factory default setup
L2	Recall power-on setup

SRQ Mask

M0	Disable SRQ
M1	Reading done
M2	Buffer half full
M4	Buffer full
M8	Reading overflow
M16	Ready for command
M32	Error
M128	Ready for trigger

Enable/Disable Analog and Digital Filters

N0	Filters off
N1	Filters on

Analog Filter Configuration

O0	Configure analog filter off
O1	Configure analog filter on

Digital Filter Configuration

P0	Configure digital filter off
P1	Configure fast response
P2	Configure medium response
P3	Configure slow response

Trigger Interval

Qvalue Interval=value in msec (10-999 999msec)

Range

R0	Enable auto-range
R1	3mV range
R2	30mV range
R3	300mV range
R4	3V range
R5	30V range
R6	No function
R7	No function
R8	Disable auto-range

Integration Period

S0	Line cycle integration period
S1	3msec integration period
S2	100msec integration period

Trigger Mode and Source

T0	Multiple on talk
T1	One-shot on talk
T2	Multiple on GET
T3	One-shot on GET
T4	Multiple on X
T5	One-shot on X
T6	Multiple on external
T7	One-shot on external
T8	Multiple on manual (MANUAL key or H0X)
T9	One-shot on manual (MANUAL key or H0X)
T10	Disable all triggers

Alternate Output

U0	Send machine status
U1	Send error conditions
U2	Send firmware revision
U3	Send buffer length
U4	Send buffer average
U5	Send buffer standard deviation
U6	Send reading relative value
U7	Send analog output relative value
U8	Send analog output gain value
U9	Send trigger interval
U10	Send trigger delay
U11	Send calibration constants
U12	Send calibration lock status
U13	Send Model 181-like machine status
U14	Send ASCII text string

Analog Output Mode, Gain, and Output Value

V0, gain	Normal mode, gain (.001-999 999.999)
V1, value	Source mode, output=value (-3.3 to +3.3)

Trigger Delay

W0	Disable trigger delay
Wvalue	Enable trigger delay, delay=value (1msec to 999 999 msec)

Execute

X	Execute other device-dependent commands
---	---

Terminators

Y0	<CR LF>
Y1	<LF CR>
Y2	<CR>
Y3	<LF>
Y10	<CR LF>
Y13	<LF CR>

Reading Relative

Z0	Disable reading relative
Z1	Enable reading relative using next reading
Z2, value	Enable reading relative using value
Z3	Enable reading relative, use present value

DATA FORMATS

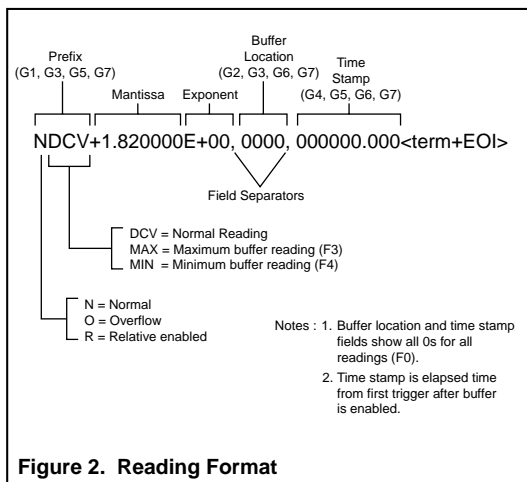
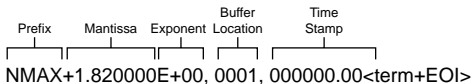
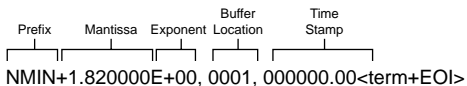

Figure 2. Reading Format



- Notes :
1. G7 reading format shown. Presence of prefix, buffer location, and time stamp depends on selected data format.
 2. Buffer location and time stamp values are at location of maximum buffer reading.

Figure 3. Maximum Buffer Value Format



- Notes :
1. G7 reading format shown. Presence of prefix, buffer location, and time stamp depends on selected data format.
 2. Buffer location and time stamp values are at location of minimum buffer reading.

Figure 4. Minimum Buffer Value Format

SRQ MASK AND SERIAL POLL BYTE

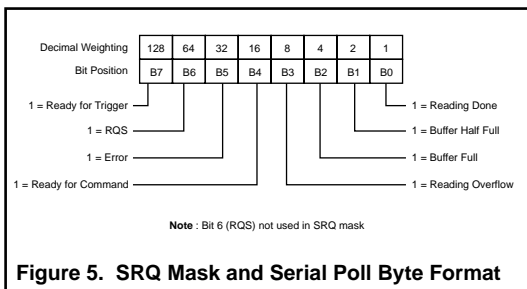

ALTERNATE OUTPUT WORD FORMATS

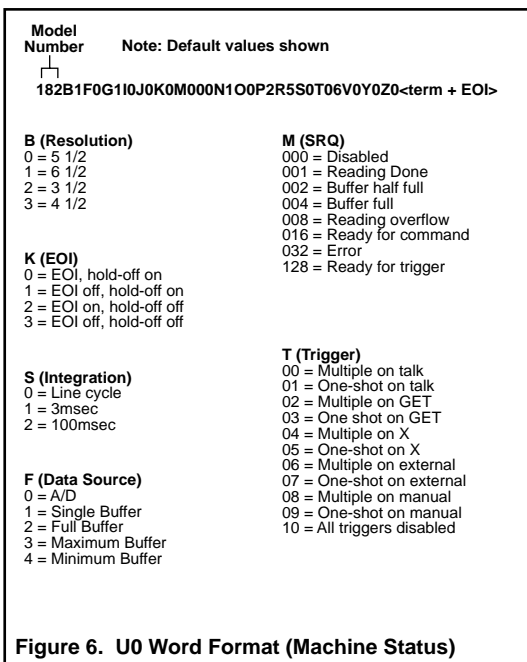

Figure 6. U0 Word Format (Machine Status)

G (Data Format)

- 0 = Reading only
- 1 = Prefix
- 2 = Location
- 3 = Location, prefix
- 4 = Time stamp
- 5 = Time stamp, prefix
- 6 = Time stamp, location
- 7 = Prefix, location, and time stamp

N (Filters)

- 0 = Off
- 1 = On

V (Output Configure)

- 0 = Normal
- 1 = Source

I (Buffer)

- 0 = Disabled
- 1 = Linear
- 2 = Circular

P (Digital Filter)

- 0 = Disabled
- 1 = Fast
- 2 = Medium
- 3 = Slow

O (Analog Filter)

- 0 = Off
- 1 = On

Y (Terminator)

- 0 = <CR> <LF>
- 1 = <LF> <CR>
- 2 = <CR>
- 3 = <LF>

J (Output Relative)

- 0 = Disabled
- 1 = Enabled, use next reading
- 2 = Enabled using value
- 3 = Enabled using present value

R (Range)

- 0 = Auto
- 1 = 3mV
- 2 = 30mV
- 3 = 300mV
- 4 = 3V
- 5 = 30V

Z (Reading Relative)

- 0 = Disabled
- 1 = Enable using reading
- 2 = Enabled using value
- 3 = Enabled using present value

U0 Word Format (Machine Status) (Cont.)

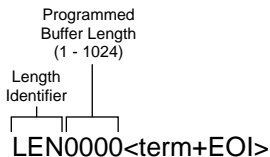

Figure 9. U3 Word Format (Buffer Length)

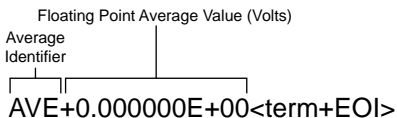

Figure 10. U4 Word Format (Buffer Average)

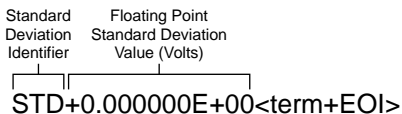

Figure 11. U5 Word Format (Buffer Standard Deviation)

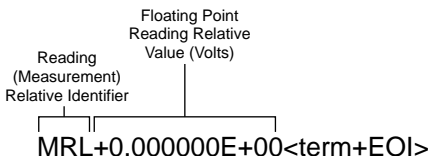

Figure 12. U6 Word Format (Reading Relative Value)

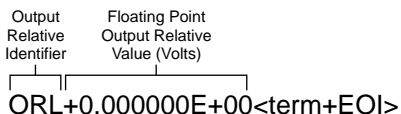

Figure 13. U7 Word Format (Analog Output Relative Value)

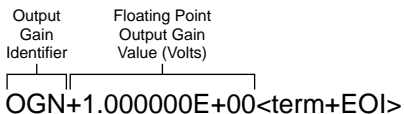

Figure 14. U8 Word Format (Analog Output Gain)

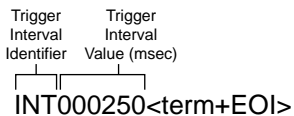

Figure 15. U9 Word Format (Trigger Interval)

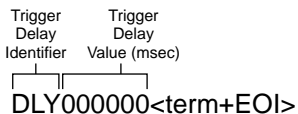

Figure 16. U10 Word Format (Trigger Delay)

Calibration
Constants
Identifier

3mV PFS 3mV NFS 3mV Zero
CAL+4.000000E-01 , +4.000000E-01 , +5.000000E-08,

30mV PFS 30mV NFS 30mV Zero
+4.000000E-01 , +4.000000E-01 , +4.000000E-08,

300mV PFS 300mV NFS 300mV Zero
+4.000000E-01 , +4.000000E-01 , +5.000000E-08,

3V PFS 3V NFS 3V Zero
+4.000000E-01 , +4.000000E+01 , +4.000000E+07,

30V PFS 30V NFS 30V Zero
+4.000000E-01 , +4.000000E+01 , +.000000E+0 ,

Divider Source PFS Source Zero
+1.000000E-00 , +0.000000E+00 , +.000000E+00 <term+EOI>

- Notes:**
1. String shown broken down for clarity. Actual string is sent as continuous string.
 2. PFS = positive full scale; NFS = negative full scale.
 3. Actual calibration values are determined at calibration time and will vary from those shown.

Figure 17. U11 Word Format (Calibration Constants)

Calibration
Lock
Identifier

LCK 1 <term+EOI>

1 = Calibration locked
0 = Calibration unlocked

Figure 18. U12 Word Format (Calibration Lock Status)

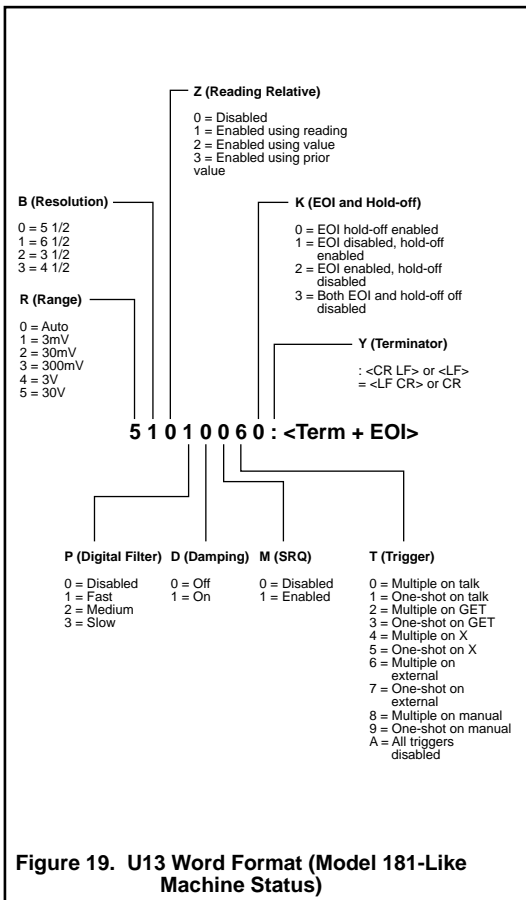

Figure 19. U13 Word Format (Model 181-Like Machine Status)

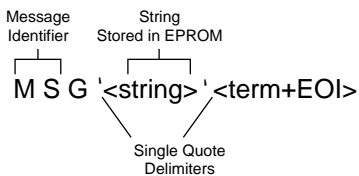

Figure 20. U14 Word Format (ASCII Message String)

Specifications are subject to change without notice.

All Keithley trademarks and trade names are the property of Keithley Instruments, Inc. All other trademarks and trade names are the property of their respective companies.



Keithley Instruments, Inc.

28775 Aurora Road • Cleveland, Ohio 44139 • 440-248-0400 • Fax: 440-248-6168
1-888-KEITHLEY (534-8453) www.keithley.com

© Copyright 2000 Keithley Instruments, Inc.
Printed in the U.S.A.